

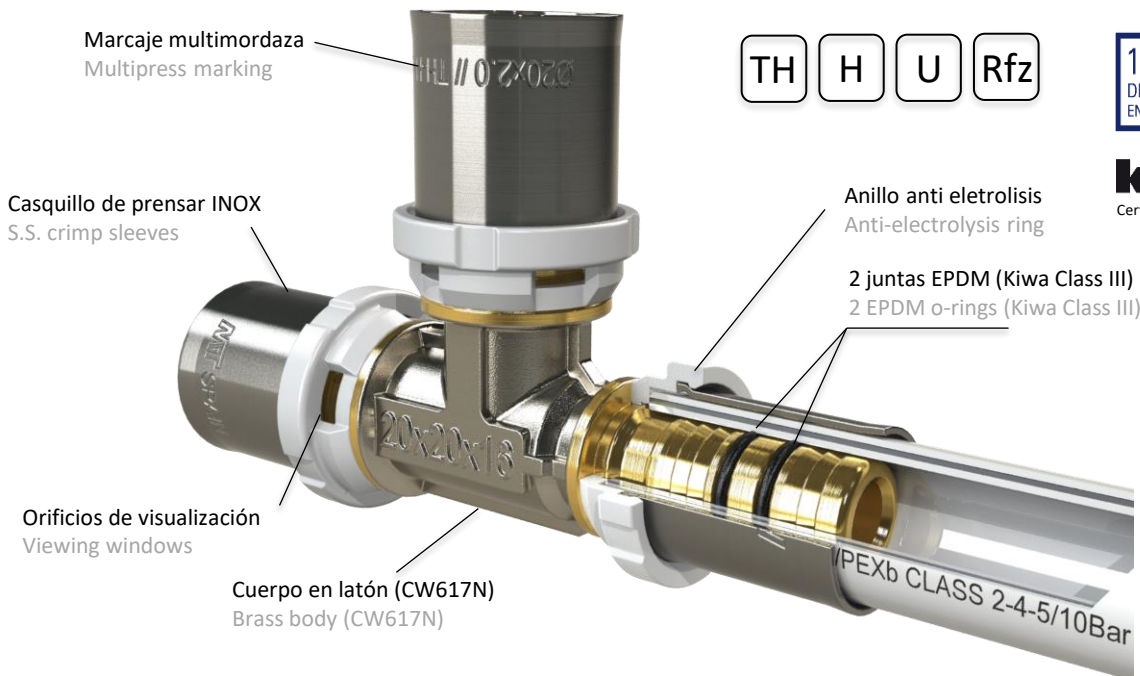

Serie 642

DESCRIPCIÓN: Accesorio de prensar para tubería Multicapa
DESCRIPTION: Press fitting for multilayer pipes

REVISIÓN / UPDATE 15: 29.06.2023 · Pag. 1/13



Características técnicas / Technical features

- Cuerpo en latón CW617N, fabricado s/ UNE 12165.
- Body in brass CW617N, manufactured according to UNE EN 12165.
- Diseñado y probado según normativa UNE EN ISO 21003.
- Designed and tested according to standard UNE EN ISO 21003.
- Compatible con tubería Multicapa de diámetros: Ø16x2, Ø20x2, Ø25x2.5, Ø26x3 y Ø32x3.
- Compatible for Multilayer pipes of diameters: Ø16x2, Ø20x2, Ø25x2.5, Ø26x3 and Ø32x3.
- Diseño compatible con mordazas de prensado tipo TH-H-U-Rfz
- Compatible design with press crimper profiles type TH-H-U-Rfz
- Estanqueidad asegurada con 2 o-rings de EPDM (Kiwa Clase III)
- Guaranteed sealing with 2 EPDM o-rings (Kiwa Class III)
- Marcaje duradero (medida y fabricante) incluido cuerpo y anillos de prensado.
- Permanent marking (size and brand) included in bodies and crimp sleeves.
- Perfil dentado con bisel de ángulo óptimo para facilitar la inserción del tubo.
- Toothed profile with optimum angle bevel in order to facilitate the insertion of the pipe.
- Temperatura máxima de trabajo: 95°C a 10 bar.
- Maximum working temperature : 95°C at 10 bar.

MT Business Key, S.L. se reserva el derecho de modificar en parte o en su totalidad las características de sus productos sin previo aviso.
MT Business Key, S.L. keeps the right to modify in part or totally the characteristics of its products without previous notice.



Para prevenir roturas, accidentes o daños severos, NO USAR este producto fuera de los límites técnicos y sus aplicaciones. Las normas locales pueden regular el uso de este producto.

To avoid abnormal operation, accidents or serious injury, DO NOT use this product outside of the specification range. Local regulations may regulate the use of this product.

Business Key, S.L

Polígono Sector Camps d'en Ricard
C/ Comerç, 10, naves 4-9 · 08780 Pallejà – Barcelona – España
Tel. +34 936 804 980 / Fax +34 936 804 981 · ventas@mtspain.net
mtspain.net

Sistema multiperfil / Multiprofile System

El nuevo accesorio MT de prensar para tubería multicapa ha sido diseñado específicamente para poder ser usado con diferentes tipos de perfiles de prensado : TH, H, U y Rfz. (ver más abajo)

Por otro lado, el sistema formado por la tubería multicapa y el accesorio ha sido probado según los requisitos de la normativa UNE-EN ISO 21003.

The new MT press fitting for multilayer pipes has been specifically designed to be used with different type of crimping profiles: TH,H,U and Rfz. (read below)

Also, the system formed by the multilayer pipe and the fitting have been tested according to the requirements of the standard UNE-EN ISO 21003.

La geometría de su perfil dentado combinado con un sistema de doble junta tórica EDPM (clase III certificada por KIWA) permiten un ajuste de inserción suave entre el accesorio y el tubo.

Además sus ventanas de visualización situadas en el anillo anti electrolisis permiten verificar que el tubo multicapa haya sido insertado correctamente.

The geometry of its toothed profile combined with a double EPDM o-ring (class III certified by Kiwa) let a soft insertion fit between the pipe and the fitting.

Furthermore their viewing windows placed on the anti-electrolisis ring allow verifying that the pipe has been inserted correctly.

Gracias a la calidad y a las certificaciones de los materiales empleados, los nuevos accesorios de prensar MT son aptos para su utilización en instalaciones de agua para consumo humano. Además están específicamente diseñados para instalaciones de agua caliente, calefacción y suelo radiante (S/ UNE 53960EX clase 1,2,4 y 5)

Due to the quality and certifications of the materials employed, the new MT press fittings are suitable for use on distribution systems of drinking water. Furthermore they're specifically designed for hot water, heating and underfloor heating systems (S/ UNE 53960EX class 1,2,4 y 5).



Perfil tipo "TH"
Profile type "TH"



Perfil tipo "H"
Profile type "H"

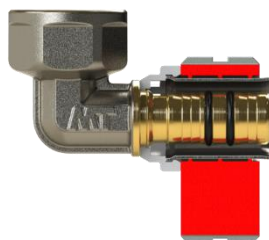

Perfil tipo "U"
Profile type "U"



Perfil tipo "Rfz"
Profile type "Rfz"

TUBO PIPE		PERFILES DE PRENSADO CRIMPING PROFILES			
ØEXT	ESPESOR	TH	H	U	Rfz
ØEXT	THICKNESS				
16	2.0	✓	✓	✓	✓
20	2.0	✓	✓	✓	✓
25	2.5	✓	✓	✓	✓
26	3.0	✓	✓	x	x
32	3.0	✓	✓	✓	✓

MT Business Key, S.L. se reserva el derecho de modificar en parte o en su totalidad las características de sus productos sin previo aviso.
MT Business Key, S.L. keeps the right to modify in part or totally the characteristics of its products without previous notice.



Para prevenir roturas, accidentes o daños severos, NO USAR este producto fuera de los límites técnicos y sus aplicaciones. Las normas locales pueden regular el uso de este producto.

To avoid abnormal operation, accidents or serious injury, DO NOT use this product outside of the specification range. Local regulations may regulate the use of this product.

Business Key, S.L

Polígono Sector Camps d'en Ricard
C/ Comerç, 10, naves 4-9 · 08780 Pallejà – Barcelona – España
Tel. +34 936 804 980 / Fax +34 936 804 981 · ventas@mtspain.net
mtspain.net

Instrucciones de montaje / Installation instructions

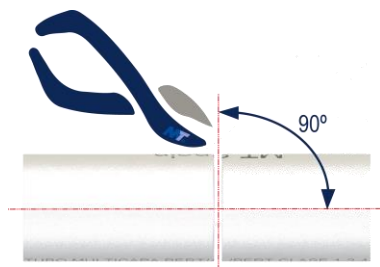

1. Cortar el tubo de forma perpendicular al eje usando el cortatubos.

Make a perpendicular cut to the pipeline using a pipe cutter.



- Insertar el extremo del tubo multicapa en el accesorio
- *Insert the end of the multilayer pipe in the fitting*
- Verificar mediante las ventanas de visualización que el tubo se ha insertado completamente
- *Verify by means of their viewing windows that the pipe has been inserted completely.*



2. Calibrar el tubo usando el calibrador. (Ref.6400)

Calibrate the pipe using the gauge. (Ref.6400)

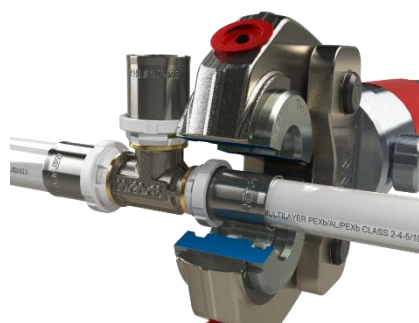

Para el prensado del accesorio, se recomienda usar una máquina con fuerza de apriete igual o superior a 15kN.

For pressing the fitting, it's recommended using a pressing tool which a crimping force equal to 15 kN or higher

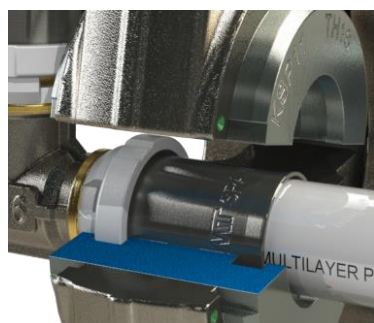

Posicionar correctamente la mordaza en el accesorio (imagen ejemplo con perfil "TH").

Place correctly the press crimp in the fitting (example picture using "TH" profile).



Prensar completamente el accesorio.

Press the fitting completely.

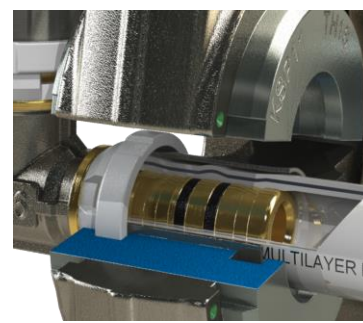

Una vez prensado, casquillo y tubería se adaptan al perfil del accesorio garantizando la estanquidad.

After pressing, sleeves and pipe adapt their shapes to the fitting's profile ensuring the tightness

MT Business Key, S.L. se reserva el derecho de modificar en parte o en su totalidad las características de sus productos sin previo aviso.
 MT Business Key, S.L. keeps the right to modify in part or totally the characteristics of its products without previous notice.



Para prevenir roturas, accidentes o daños severos, NO USAR este producto fuera de los límites técnicos y sus aplicaciones. Las normas locales pueden regular el uso de este producto.

To avoid abnormal operation, accidents or serious injury, DO NOT use this product outside of the specification range. Local regulations may regulate the use of this product.

Business Key, S.L

Polígono Sector Camps d'en Ricard
 C/ Comerç, 10, naves 4-9 · 08780 Pallejà – Barcelona – España
 Tel. +34 936 804 980 / Fax +34 936 804 981 · ventas@mtspain.net
 mtspain.net

642090



Codo 90°
Equal elbow 90°

642091



Codo hembra 90°
Female elbow 90°

642092



Codo macho 90°
Male elbow 90°

642130



Racor "T"
Equal Tee

642131



Racor "T" hembra
Female tee

642132



Racor "T" macho
Male tee

642133



"T" reducida
Reducing tee

642270



Manguito acoplamiento
Straight coupling

642271



Racor recto hembra
Straight Female connector

642272



Racor recto macho
Straight male connector

642273



Manguito acoplamiento
reducido
Reducing straight connector

642274



Racor hembra tuerca móvil
Loose nut Female connector

642500



Racor codo mural
Wall plated elbow

MT Business Key, S.L. se reserva el derecho de modificar en parte o en su totalidad las características de sus productos sin previo aviso.
MT Business Key, S.L. keeps the right to modify in part or totally the characteristics of its products without previous notice.



Para prevenir roturas, accidentes o daños severos, NO USAR este producto fuera de los límites técnicos y sus aplicaciones. Las normas locales pueden regular el uso de este producto.

To avoid abnormal operation, accidents or serious injury, DO NOT use this product outside of the specification range. Local regulations may regulate the use of this product.

Business Key, S.L

Polígono Sector Camps d'en Ricard
C/ Comerç, 10, naves 4-9 · 08780 Pallejà – Barcelona – España
Tel. +34 936 804 980 / Fax +34 936 804 981 · ventas@mtspain.net
mtspain.net

Válvulas / Valves

40642



Válvula esfera multicapa
Palanca INOX
*Multilayer ball valve with
S.S. handle*

41642



Válvula esfera multicapa
mando palomilla
*Multilayer ball valve with
butterfly handle*

42642



Válvula esfera multicapa
para empotrar
*Long neck multilayer ball
valve*

45642



Válvula esfera conexiones
multicapa-tuerca móvil y
mando palomilla
*Multilayer ball valve with
loose nut conector and
butterfly handle*

Tubería / Pipes

640



Tubo multicapa
PE-Xb/AL/PE-Xb
*Multilayer pipe
PE-Xb/AL/PE-Xb*

64015

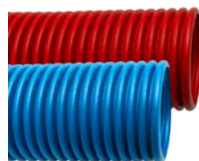

Tubo corrugado
Corrugated pipe

64016

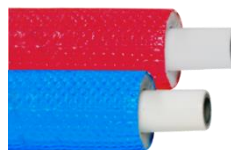

Tubo Multicapa Aislado
Isolated multilayer pipe

645



Tubo PE-Xa / PE-Xa Evoh
PE-Xa / PE-Xa Evoh pipes

Herramientas / Tools

MAP115



Maletín multicapa Press
Multilayer Press toolbox

6400



Calibradores
Gauges

6402



Muelle curvatubos
Bending springs

6403



Cortatubos automático
Automatic pipe cutter

MT Business Key, S.L. se reserva el derecho de modificar en parte o en su totalidad las características de sus productos sin previo aviso.
MT Business Key, S.L. keeps the right to modify in part or totally the characteristics of its products without previous notice.



Para prevenir roturas, accidentes o daños severos, NO USAR este producto fuera de los límites técnicos y sus aplicaciones. Las normas locales pueden regular el uso de este producto.

To avoid abnormal operation, accidents or serious injury, DO NOT use this product outside of the specification range. Local regulations may regulate the use of this product.

Business Key, S.L

Polígono Sector Camps d'en Ricard
C/ Comerç, 10, naves 4-9 · 08780 Pallejà – Barcelona – España
Tel. +34 936 804 980 / Fax +34 936 804 981 · ventas@mtspain.net
mtspain.net

Accesorios / Fittings

642090 Codo 90° Equal elbow 90°

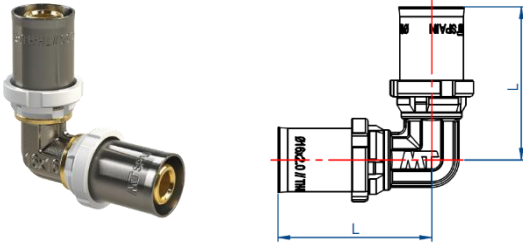

CODIGO CODE	MEDIDA SIZE	ESPESOR THICKNESS			L
642090-016	16	2.0	100	10	44
642090-020	20	2.0	70	10	46
642090-025	25	2.5	50	5	56
642090-026	26	3.0	50	5	56
642090-032	32	3.0	30	3	58

642091 Codo hembra 90° Female elbow 90°

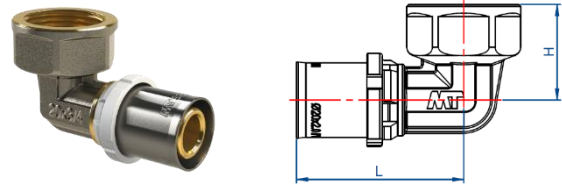

CODIGO CODE	MEDIDA SIZE	ESPESOR THICKNESS			H	L
642091-01615	16 x 1/2"	2.0	120	10	25	46
642091-02015	20 x 1/2"	2.0	90	10	28	48
642091-02020	20 x 3/4"	2.0	70	10	29	51
642091-02520	25 x 3/4"	2.5	50	5	33	56
642091-02525	25 x 1"	2.5	40	5	36	59
642091-02620	26 x 3/4"	3.0	50	5	33	56
642091-02625	26 x 1"	3.0	40	5	36	59
642091-03225	32 x 1"	3.0	30	3	40	59

642092 Codo macho 90° Male elbow 90°

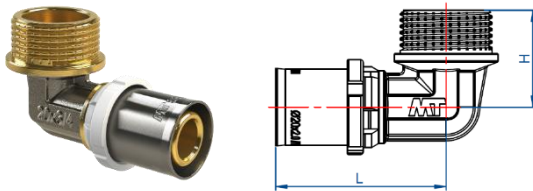

CODIGO CODE	MEDIDA SIZE	ESPESOR THICKNESS			H	L
642092-01615	16 x 1/2"	2.0	140	10	25	46
642092-02015	20 x 1/2"	2.0	100	10	28	48
642092-02020	20 x 3/4"	2.0	80	10	29	51
642092-02520	25 x 3/4"	2.5	60	5	33	56
642092-02525	25 x 1"	2.5	50	5	36	59
642092-02620	26 x 3/4"	3.0	60	5	33	56
642092-02625	26 x 1"	3.0	50	5	36	59
642092-03225	32 x 1"	3.0	30	3	40	59

642130 Racor "T" Equal Tee

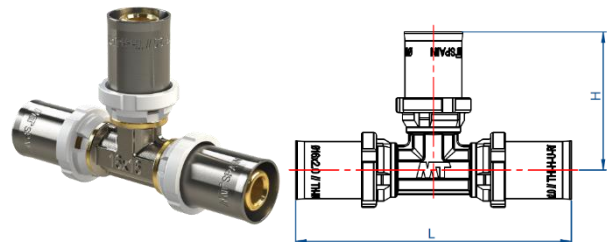

CODIGO CODE	MEDIDA SIZE	ESPESOR THICKNESS			H	L
642130-016	16	2.0	70	5	44	87
642130-020	20	2.0	50	5	46	92
642130-025	25	2.5	30	3	54	108
642130-026	26	3.0	30	3	54	108
642130-032	32	3.0	18	2	57	114

MT Business Key, S.L. se reserva el derecho de modificar en parte o en su totalidad las características de sus productos sin previo aviso.
MT Business Key, S.L. keeps the right to modify in part or totally the characteristics of its products without previous notice.



Para prevenir roturas, accidentes o daños severos, NO USAR este producto fuera de los límites técnicos y sus aplicaciones. Las normas locales pueden regular el uso de este producto.

To avoid abnormal operation, accidents or serious injury, DO NOT use this product outside of the specification range. Local regulations may regulate the use of this product.

Business Key, S.L

Polígono Sector Camps d'en Ricard
C/ Comerç, 10, naves 4-9 · 08780 Pallejà – Barcelona – España
Tel. +34 936 804 980 / Fax +34 936 804 981 · ventas@mtspain.net
mtspain.net



Management System
ISO 9001:2015

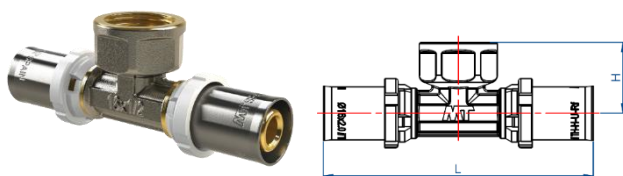

www.tuv.com
ID: 9108643013

642131Racor "T" hembra
Female tee

CODIGO CODE	MEDIDA SIZE	ESPESOR THICKNESS			H	L
642131-01615	16 x 1/2"	2.0	80	5	25	92
642131-02015	20 x 1/2"	2.0	60	5	27	92
642131-02020	20 x 3/4"	2.0	50	5	29	100
642131-02520	25 x 3/4"	2.5	42	3	33	110
642131-02525	25 x 1"	2.5	30	3	36	118
642131-02620	26 x 3/4"	3.0	42	3	33	110
642131-02625	26 x 1"	3.0	30	3	36	118
642131-03225	32 x 1"	3.0	24	2	40	118

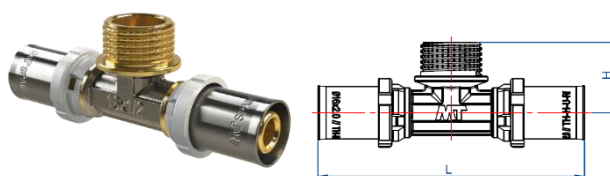
642132Racor "T" macho
Male tee

CODIGO CODE	MEDIDA SIZE	ESPESOR THICKNESS			H	L
642132-01615	16 x 1/2"	2.0	80	5	25	92
642132-02015	20 x 1/2"	2.0	60	5	27	92
642132-02020	20 x 3/4"	2.0	50	5	29	100
642132-02520	25 x 3/4"	2.5	42	3	33	110
642132-02525	25 x 1"	2.5	30	3	36	118
642132-02620	26 x 3/4"	3.0	42	3	33	110
642132-02625	26 x 1"	3.0	30	3	36	118
642132-03225	32 x 1"	3.0	24	2	40	118

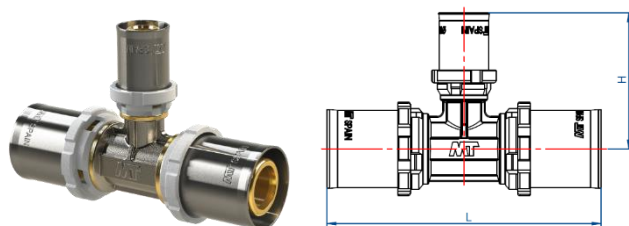
642133"T" reducida
Reducing tee

CODIGO CODE	MEDIDA SIZE	ESPESOR THICKNESS			H	L
642133-01620	16 x 20 x 16	2.0 x 2.0 x 2.0	60	5	46	90
642133-02016	20 x 16 x 20	2.0 x 2.0 x 2.0	50	5	46	90
642133-02516	25 x 16 x 25	2.5 x 2.0 x 2.5	36	3	50	100
642133-02520	25 x 20 x 25	2.5 x 2.0 x 2.5	36	3	50	105
642133-02616	26 x 16 x 26	3.0 x 2.0 x 3.0	36	3	50	100
642133-02620	26 x 20 x 26	3.0 x 2.0 x 3.0	36	3	50	105
642133-03216	32 x 16 x 32	3.0 x 2.0 x 3.0	24	2	52	100
642133-03220	32 x 20 x 32	3.0 x 2.0 x 3.0	24	2	52	102
642133-03225	32 x 25 x 32	3.0 x 2.5 x 3.0	24	2	57	107
642133-03226	32 x 26 x 32	3.0 x 3.0 x 3.0	24	2	57	107

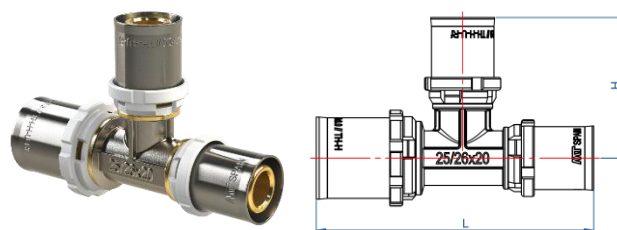
642134"T" reducida
Reducing tee

CODIGO CODE	MEDIDA SIZE	ESPESOR THICKNESS			H	L
642134-01620	20 x 16 x 16	2.0 x 2.0 x 2.0	60	5	46	90
642134-02520	25 x 20 x 20	2.5 x 2.0 x 2.0	36	3	50	100
642134-02620	26 x 20 x 20	3.0 x 2.0 x 2.0	36	3	50	100

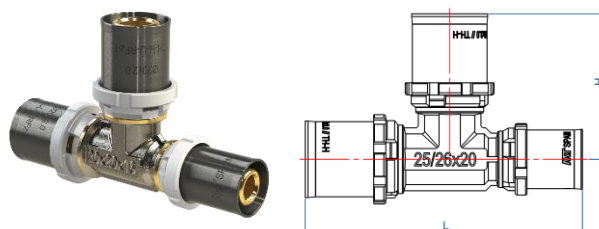
642135"T" reducida
Reducing tee

CODIGO CODE	MEDIDA SIZE	ESPESOR THICKNESS			H	L
642135-02016	20 x 20 x 16	2.0 x 2.0 x 2.0	50	5	46	92
642135-02520	25 x 25 x 20	2.5 x 2.5 x 2.0	36	3	55	105
642135-02620	26 x 26 x 20	3.0 x 3.0 x 2.0	36	3	55	105

MT Business Key, S.L. se reserva el derecho de modificar en parte o en su totalidad las características de sus productos sin previo aviso.
 MT Business Key, S.L. keeps the right to modify in part or totally the characteristics of its products without previous notice.



Para prevenir roturas, accidentes o daños severos, NO USAR este producto fuera de los límites técnicos y sus aplicaciones. Las normas locales pueden regular el uso de este producto.

To avoid abnormal operation, accidents or serious injury, DO NOT use this product outside of the specification range. Local regulations may regulate the use of this product.

Business Key, S.L

Polígono Sector Camps d'en Ricard
 C/ Comerç, 10, naves 4-9 · 08780 Pallejà – Barcelona – España
 Tel. +34 936 804 980 / Fax +34 936 804 981 · ventas@mtspain.net
 mtspain.net

642270

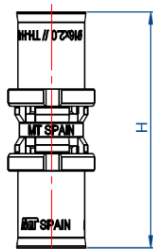
Manguito acoplamiento
Straight coupling

CODIGO CODE	MEDIDA SIZE	ESPESOR THICKNESS			H
642270-016	16	2.0	130	10	63
642270-020	20	2.0	70	10	64
642270-025	25	2.5	60	5	74
642270-026	26	3.0	60	5	74
642270-032	32	3.0	36	3	74

642271

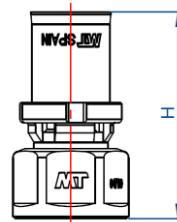
Racor recto hembra
Straight female coupling

CODIGO CODE	MEDIDA SIZE	ESPESOR THICKNESS			H
642271-01615	16 x 1/2"	2.0	120	10	48
642271-01620	16 x 3/4"	2.0	120	10	50
642271-02015	20 x 1/2"	2.0	120	10	49
642271-02020	20 x 3/4"	2.0	100	10	50
642271-02520	25 x 3/4"	2.5	70	5	53
642271-02525	25 x 1"	2.5	60	5	58
642271-02620	26 x 3/4"	3.0	70	5	53
642271-02625	26 x 1"	3.0	60	5	58
642271-03225	32 x 1"	3.0	60	3	60

642272

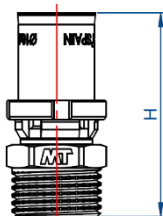
Racor recto macho
Straight male coupling

CODIGO CODE	MEDIDA SIZE	ESPESOR THICKNESS			H
642272-01615	16 x 1/2"	2.0	180	10	48
642272-01620	16 x 3/4"	2.0	140	10	50
642272-02015	20 x 1/2"	2.0	120	10	49
642272-02020	20 x 3/4"	2.0	100	10	50
642272-02520	25 x 3/4"	2.5	60	5	56
642272-02525	25 x 1"	2.5	60	5	58
642272-02620	26 x 3/4"	3.0	60	5	56
642272-02625	26 x 1"	3.0	60	5	58
642272-03225	32 x 1"	3.0	48	3	60

642273

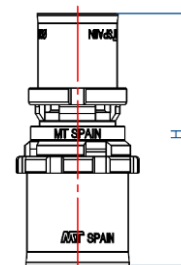
Manguito acoplamiento reducido
Reducing straight coupling

CODIGO CODE	MEDIDA SIZE	ESPESOR THICKNESS			H
642273-02016	20 x 16	2.0 x 2.0	90	10	47
642273-02520	25 x 20	2.5 x 2.0	60	5	71
642273-02620	26 x 20	3.0 x 2.0	60	5	71
642273-03225	32 x 25	3.0 x 2.5	48	3	76
642273-03226	32 x 26	3.0 x 3.0	48	3	76

MT Business Key, S.L. se reserva el derecho de modificar en parte o en su totalidad las características de sus productos sin previo aviso.
 MT Business Key, S.L. keeps the right to modify in part or totally the characteristics of its products without previous notice.





Para prevenir roturas, accidentes o daños severos, NO USAR este producto fuera de los límites técnicos y sus aplicaciones. Las normas locales pueden regular el uso de este producto.

To avoid abnormal operation, accidents or serious injury, DO NOT use this product outside of the specification range. Local regulations may regulate the use of this product.



Business Key, S.L

Polígono Sector Camps d'en Ricard
 C/ Comerç, 10, naves 4-9 · 08780 Pallejà – Barcelona – España
 Tel. +34 936 804 980 / Fax +34 936 804 981 · ventas@mtspain.net
 mtspain.net

642274**Racor recto hembra tuerca móvil**
Loose nut female connector

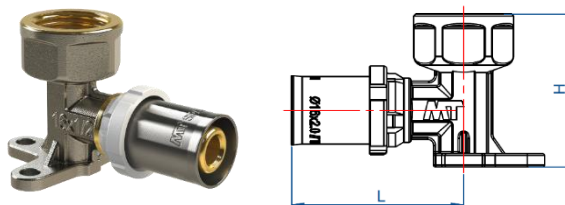
CODIGO <i>CODE</i>	MEDIDA <i>SIZE</i>	ESPESOR <i>THICKNESS</i>			H
642274-01615	16 x 1/2"	2.0	160	10	45
642274-01620	16 x 3/4"	2.0	130	10	45
642274-02015	20 x 1/2"	2.0	110	10	45
642274-02020	20 x 3/4"	2.0	90	10	45
642274-02520	25 x 3/4"	2.5	60	5	50
642274-02525	25 x 1"	2.5	60	5	50
642274-02620	26 x 3/4"	3.0	60	5	50
642274-02625	26 x 1"	3.0	60	5	50
642274-03225	32 x 1"	3.0	42	3	52

642500**Racor codo mural**
Wall plated elbow

CODIGO <i>CODE</i>	MEDIDA <i>SIZE</i>	ESPESOR <i>THICKNESS</i>			H	L
642500-01615	16 x 1/2"	2.0	80	10	41	46
642500-02015	20 x 1/2"	2.0	70	5	43	46
642500-02020	20 x 3/4"	2.0	50	5	45	50

MT Business Key, S.L. se reserva el derecho de modificar en parte o en su totalidad las características de sus productos sin previo aviso.
MT Business Key, S.L. keeps the right to modify in part or totally the characteristics of its products without previous notice.



Para prevenir roturas, accidentes o daños severos, NO USAR este producto fuera de los límites técnicos y sus aplicaciones. Las normas locales pueden regular el uso de este producto.

To avoid abnormal operation, accidents or serious injury, DO NOT use this product outside of the specification range. Local regulations may regulate the use of this product.



Business Key, S.L

Polígono Sector Camps d'en Ricard
 C/ Comerç, 10, naves 4-9 · 08780 Pallejà – Barcelona – España
 Tel. +34 936 804 980 / Fax +34 936 804 981 · ventas@mtspain.net
 mtspain.net

Válvulas / Valves

40642

Válvula esfera conex. Multicapa Press palanca INOX
Multilayer brass ball valve S.S. handle

CODIGO CODE	MEDIDA SIZE			L	H	M	
40642-016	406422-016	Ø16 x 2.0	48	12	103	49	83
40642-020	406422-020	Ø20 x 2.0	48	12	103	49	83
40642-025	406422-025	Ø25 x 2.5	16	4	120	52	93
40642-026	406422-026	Ø26 x 3.0	16	4	120	52	93
40642-032	406422-032	Ø32 x 3.0	16	4	128	61	105

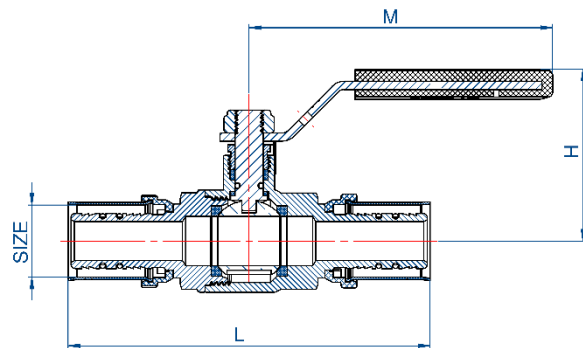

Palanca roja /
Red Handle

Palanca azul /
Blue Handle



41642

Válvula esfera conex. Multicapa mando palomilla
Multilayer brass ball valve butterfly handle

CODIGO CODE	MEDIDA SIZE			L	H	M
41642-016	Ø16 x 2.0	48	12	103	39	52
41642-020	Ø20 x 2.0	48	12	103	39	52
41642-025	Ø25 x 2.5	28	7	120	42	52
41642-026	Ø26 x 3.0	28	7	120	42	52
41642-032	Ø32 x 3.0	16	4	128	52	67

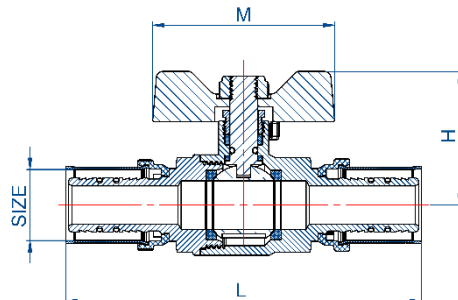

MT Business Key, S.L. se reserva el derecho de modificar en parte o en su totalidad las características de sus productos sin previo aviso.
 MT Business Key, S.L. keeps the right to modify in part or totally the characteristics of its products without previous notice.



Para prevenir roturas, accidentes o daños severos, NO USAR este producto fuera de los límites técnicos y sus aplicaciones. Las normas locales pueden regular el uso de este producto.



To avoid abnormal operation, accidents or serious injury, DO NOT use this product outside of the specification range. Local regulations may regulate the use of this product.

Business Key, S.L

Polígono Sector Camps d'en Ricard
 C/ Comerç, 10, naves 4-9 · 08780 Pallejà – Barcelona – España
 Tel. +34 936 804 980 / Fax +34 936 804 981 · ventas@mtspain.net
 mtspain.net

42642

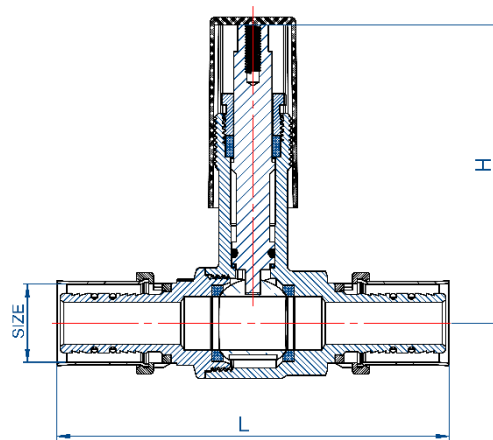

Válvula esfera empotrar conex. Multicapa Press
Long neck Multilayer brass ball valve.

CODIGO CODE	MEDIDA SIZE			L	H
42642-016	Ø16 x 2.0	32	8	103	80
42642-020	Ø20 x 2.0	32	8	103	80
42642-025	Ø25 x 2.5	24	6	120	82
42642-026	Ø26 x 3.0	24	6	120	82
42642-032	Ø32 x 3.0	12	3	128	85



45642

Válvula esfera conex. Multicapa Press-tuerca móvil y mando palomilla
Multilayer brass ball valve with loose nut and butterfly handle

CODIGO CODE	MEDIDAS SIZE 1	SIZE 2			L	H	M
45642-016	Ø16 x 2.0	3/4"	48	12	91	39	52
45642-020	Ø20 x 2.0	3/4"	48	12	91	39	52
45642-025	Ø25 x 2.5	3/4"	32	7	102	42	52
45642-026	Ø26 x 3.0	3/4"	32	7	102	42	52

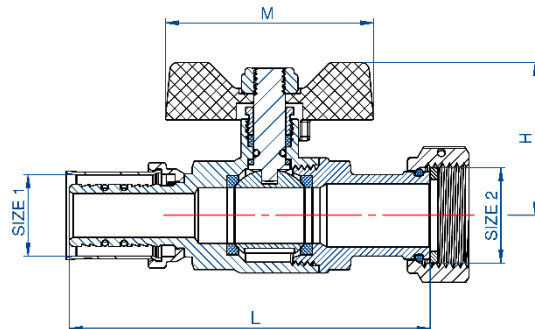

MT Business Key, S.L. se reserva el derecho de modificar en parte o en su totalidad las características de sus productos sin previo aviso.
 MT Business Key, S.L. keeps the right to modify in part or totally the characteristics of its products without previous notice.



Para prevenir roturas, accidentes o daños severos, NO USAR este producto fuera de los límites técnicos y sus aplicaciones. Las normas locales pueden regular el uso de este producto.

To avoid abnormal operation, accidents or serious injury, DO NOT use this product outside of the specification range. Local regulations may regulate the use of this product.

Business Key, S.L

Polígono Sector Camps d'en Ricard
 C/ Comerç, 10, naves 4-9 · 08780 Pallejà – Barcelona – España
 Tel. +34 936 804 980 / Fax +34 936 804 981 · ventas@mtspain.net
 mtspain.net

Tubería / Pipes

640R

Tubo multicapa PE-Xb/AL/PE-Xb (rollos)
Multilayer pipe PE-Xb/AL/PE-Xb (rolls)



CODIGO <i>CODE</i>	MEDIDA <i>SIZE</i>	METROS <i>METERS</i>
640-015016	16 x 2.0	15
640-025016	16 x 2.0	25
640-100016	16 x 2.0	100
640-100018	18 x 2.0	100
640-015020	20 x 2.0	15
640-025020	20 x 2.0	25
640-100020	20 x 2.0	100
640-015025	25 x 2.5	15
640-025025	25 x 2.5	25
640-050025	25 x 2.5	50
640-025026	26 x 3.0	25
640-050026	26 x 3.0	50
640-025032	32 x 3.0	25
640-050032	32 x 3.0	50

640B

Tubo multicapa PE-Xb/AL/PE-Xb (barras)
Multilayer pipe PE-Xb/AL/PE-Xb (bars)

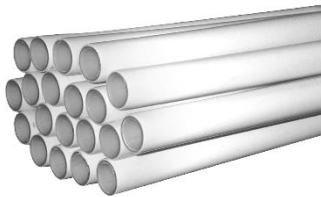

CODIGO <i>CODE</i>	MEDIDA <i>SIZE</i>	METROS <i>METERS</i>	Barras x caja <i>Bar per box</i>
640030216	16 x 2.0	2	15
640030220	20 x 2.0	2	15

64015

Tubo corrugado
Corrugated pipe

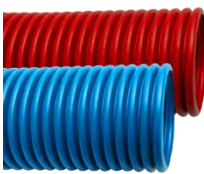

CODIGO <i>CODE</i>	CODIGO <i>CODE</i>	MEDIDA <i>SIZE</i>	Øext <i>Øext</i>	METROS <i>METERS</i>
640151-016	640152-016	16	26	50
640151-020	640152-020	20	32	50
640151-025	640152-025	25	40	50

Rojo /Red Azul/Blue

64016

Tubo multicapa aislado
Isolated multilayer pipe

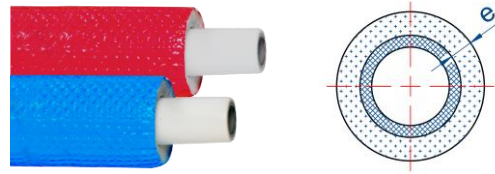

CODIGO <i>CODE</i>	CODIGO <i>CODE</i>	MEDIDA <i>SIZE</i>	ESPESOR <i>THICKNESS</i>	METROS <i>METERS</i>
640161-016	640162-019	16	6	50
640161-020	640162-020	20	6	50
640161-025	640162-025	25	9	50
640161-026	640162-026	26	9	50
640151-032	640152-032	32	9	50

Rojo /Red Azul/Blue

MT Business Key, S.L. se reserva el derecho de modificar en parte o en su totalidad las características de sus productos sin previo aviso.
 MT Business Key, S.L. keeps the right to modify in part or totally the characteristics of its products without previous notice.



Para prevenir roturas, accidentes o daños severos, NO USAR este producto fuera de los límites técnicos y sus aplicaciones. Las normas locales pueden regular el uso de este producto.

To avoid abnormal operation, accidents or serious injury, DO NOT use this product outside of the specification range. Local regulations may regulate the use of this product.

Business Key, S.L

Polígono Sector Camps d'en Ricard
 C/ Comerç, 10, naves 4-9 · 08780 Pallejà – Barcelona – España
 Tel. +34 936 804 980 / Fax +34 936 804 981 · ventas@mtspain.net
 mtspain.net

645

Tubo PE-Xa / PE-Xa Evoh
PE-Xa / PE-Xa Evoh pipes



CODIGO <i>CODE</i>	MEDIDA <i>SIZE</i>	METROS <i>METERS</i>
645100016	16 x 2.0	100
645100116*	16 x 2.0	100
645100020	20 x 2.0	100
645050120*	20 x 2.0	100
645050025	25 x 2.5	50
645050032	32 x 3.0	50

*Tubo PE-Xa Evoh en color rojo
 *PE-Xa Evoh pipe in red colour

Herramientas / Tools

6400

Calibradores
Gauges



CODIGO <i>CODE</i>	MEDIDA <i>SIZE</i>
6400-162026	16-20-26

CODIGO <i>CODE</i>	MEDIDA <i>SIZE</i>
6400-16202632	16-20-26-32

MAP115

Maletín multicapa Press
Multilayer Press toolbox



CODIGO <i>CODE</i>	MEDIDA <i>SIZE</i>	PERFIL <i>PROFILE</i>
MAP115MLS4-TH	16-32	TH

Maletín con perfiles H,U o RFz consultar
 Toolbox with profiles H,U o RFz on request

6402

Muelle curvatubos exterior
External bending springs

CODIGO <i>CODE</i>	MEDIDA <i>SIZE</i>
6402-016	16 x 2.0
6402-018	18 x 2.0
6402-020	20 x 2.0
6402-025	25 x 2.5
6402-026	26 x 3.0
6402-032	32 x 3.0



6403

Cortatubos automático
Automatic pipe cutter

CODIGO <i>CODE</i>	MEDIDA <i>SIZE</i>
6403-1242	12-42



MT Business Key, S.L. se reserva el derecho de modificar en parte o en su totalidad las características de sus productos sin previo aviso.
 MT Business Key, S.L. keeps the right to modify in part or totally the characteristics of its products without previous notice.



Para prevenir roturas, accidentes o daños severos, NO USAR este producto fuera de los límites técnicos y sus aplicaciones. Las normas locales pueden regular el uso de este producto.

To avoid abnormal operation, accidents or serious injury, DO NOT use this product outside of the specification range. Local regulations may regulate the use of this product.

Business Key, S.L

Polígono Sector Camps d'en Ricard
 C/ Comerç, 10, naves 4-9 · 08780 Pallejà – Barcelona – España
 Tel. +34 936 804 980 / Fax +34 936 804 981 · ventas@mtspain.net
 mtspain.net